

Update Systems

XT Series Users Guide

Models 1200XT, 2400XT, and 5000XT



©2019 Update Systems, Inc.
10545 Baur Blvd., St. Louis, MO 63132
Phone 314.432.3282 • Fax 314.432.7843

Controller Hardware Revision: B
Encoder Hardware Revision: B

Firmware Revision 3.21(1200 in•lbs), 4.21(2400 in•lbs), 5.21 (5000 in•lbs)
Updated: Oct 28, 2019

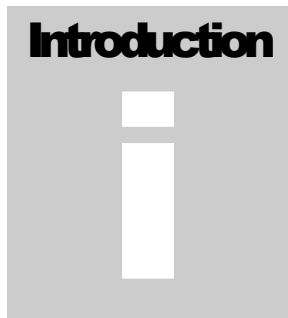

This document describes the setup and operation of the XT Series 1200, 2400 and 5000 in·lb Electric Actuator Control System. The system provides reliable control and feedback to actuate industrial valves and vanes. The XT Series is fully calibratable for 4-20 input and valve position ranges up to 179 degrees.

The manual is divided into three chapters. Chapter 1 gives an overview of the system modules and setup. Chapter 2 gives detailed instruction on navigating the operational modes of the controller. Chapter 3 provides instructions for reprogramming the controller. Carefully read the chapters Setup and Modes of Operation before running and testing the actuator.

[Chapter 1 - Setup](#) [2](#)

[Chapter 2 - Modes of Operation](#) [4](#)

- 21 [PASSCODE \[PASS\] MODE](#)
- 2.2 [MANUAL \[USER\] MODE](#)
- 23 [4-20 \[AUTO\] MODE](#)
- 24 [MODBUS \[DBUS\] MODE](#)
- 25 [MODBUS OPEN/CLOSE \[OBUS\] MODE](#)
- 26 [OPEN/CLOSE \[OPCL\] MODE](#)
- 27 [ON/OFF \[ONOF\] MODE](#)
- 28 [CALIBRATION \[CAL\] MODE](#)
 - 281 [FULL CALIBRATION ONLY \[FCAL\] MODE](#)
 - 282 [4-20mA CALIBRATION ONLY \[ICAL\] MODE](#)
 - 283 [POSITION CALIBRATION ONLY \[PCAL\] MODE](#)
- 2.9 [BACKUP CALIBRATION \[BCAL\] MODE](#)
- 210 [ERROR \[ERR\] MODE](#)
- 211 [MANUAL OVERRIDE \[OVER\] MODE](#)
- 212 [CONFIGURATION \[CNFG\] MODE](#)

[Chapter 3 – Programming](#) [29](#)



MODULE OVERVIEW



Controller

The controller consists of seven connection ports listed as follows: PWR, MOTOR, 4-20IN/OUT, MODBUS, RELAYS, and PROG. These ports are described in Table 1. The controller user interface is comprised of four buttons, one turn knob, a four-digit display, and five LED indicators.

The buttons are used for navigating menus, selecting options, viewing/clearing errors, and calibrating the unit. The knob is used for manual valve positioning during calibration and other miscellaneous tasks as described in this manual. The LED indicators are used in automatic mode to show the type of information displayed. See Table 1-1.



Actuator Assembly

The actuator assembly consists of the motor, gear box, sensor board encased in an aluminum housing, power supply¹, and backup power supply². **Any openings must be filled with a device of Type 4 or equivalent environmental rating that is tightened to 15 in. lbs. (UL)**



Programmer

The programmer is used to update the firmware of the controller. It requires a USB connection to a computer with Flash Magic boot-loader software installed. More information about updating the controller can be found in the programming section.

¹ Available 48VDC power supply option.

² Available emergency power backup supply option.

XT SERIES VALVE ACTUATOR

PORT	PIN	DESCRIPTION
PWR (POWER)	1 (GND)	Input power ground
	2 (+48V)	48VDC input power. The input is reverse voltage protected and fused. This input is suitable for an input circuit capable of delivering not more than 5,000 rms symmetrical amperes, 240 volts maximum when protected by fuses or breakers sized in accordance with the NEC. (UL)
MOTOR	1-4	Pre-assembled 4 pin, 1 row connector supplying the stepper motor drive current.
4-20IN/OUT	1 (IN +)	“Positive” input for 4-20mA current loop. This input is over voltage protected and designed to operate for reverse polarization (i.e. +IN and –IN are swapped). This input is calibrated to control the valve position in [AUTO]matic mode.
	2 (IN -)	“Negative” input for 4-20mA current loop. (see above)
	3 (OUT)	Single ended output for 4-20mA current feedback. This output is proportional to valve percent open (i.e. 4mA = 0% open and 20mA = 100% open). It directly corresponds to the current state of the valve.
	4 (GND)	Ground for 4-20mA output.
MODBUS	1 (B)	MODBUS communication port for system control and/or status. Offers increased valve resolution because of immunity to induced system noise and ability for remote monitoring.
	2 (A)	See above.
RELAYS (60Vp, 600mA max)	(ERROR 1)	Normally-closed, non-polarized relay output for system error indication. An error will cause the relay to open. See section on Error codes for more detail.
	(ERROR 2)	See above.
	(AUX 1)	Normally-closed, non-polarized relay output for valve status indication. Relay will OPEN when valve is fully OPEN. Software reconfigurable to Normally-open.
	(AUX 1)	See above.
	(AUX 2)	Normally-closed, non-polarized relay output for valve status indication. Relay will OPEN when valve is fully CLOSED. Software reconfigurable to Normally-open.
	(AUX 2)	See above.
OPEN/CLOSE ³ (ON/OFF)	1 (OPEN)	Control for opening valve. Available with 24-48VDC or 120-240VAC configuration.
	2-3 (COM)	DC Common or VAC Neutral depending on configuration.
	4 (CLOSE)	Control for closing valve. Available with 24-48VDC or 120-240VAC configuration.
PROG	1-6	Input port for XT Series Programmer. Programmer is used in conjunction with the Flash Magic boot-loader software to update the controller firmware. Also used for OPEN/CLOSE input option.

Table 1-1
XT Series Controller Port Description

³ [Optional feature] Available to order as an additional input.

Overview

The XT Series has five modes of operation, five setup modes and two special modes. The normal operational modes are 4-20 [AUto] mode, MODBUS standard [dbUS], MODBUS Open/Close [obUS], OPEN/CLOSE mode3 [oPCL], ON/OFF mode3 [onoF]. The five setup modes are Passcode [PASS] mode, Manual [USEr] mode, Calibration [CAL] mode, Backup Sensor Calibration [bCAL] mode, and Configuration [CnFg]. The special modes are Error [Err] mode and Manual Override mode [ovEr]. The normal modes, Passcode, 4-20mA, MODBUS Standard, MODBUS OPEN/CLOSE, VAC/VDC OPEN/CLOSE³, VAC/VDC ON/OFF³ may be selected at any time during normal operation. A valid passcode must be entered to access all other normal modes. The Error mode is only accessible if a system error is present.

Press the **MODE** button next to the turn knob to cycle through all available modes. Cycling through the modes with the **MODE** button does not change to that mode. A decimal in the right most corner of the display is lit for all modes available to enter. The right most decimal is not lit for the current mode. When the desired mode is displayed, press the **ENTR** button. The decimal indicator turns off to indicate that the mode has been changed. The display will revert to the submenu of the selected mode one second after it is changed. If the **ENTR** button is not pressed within two seconds the display will flash the current mode for one second and return to its submenu. The current mode of operation is active until a new mode is entered. The following sections describe each mode in more detail.

2.1 PASSCODE [PASS] MODE

A valid passcode must be entered to gain access to any normal mode other than the standard operational modes. The passcode prevents accidental recalibration or mode changes. The user passcode is **3282**. The following paragraph explains how to enter the passcode.



Fig 2.1-1



Fig 2.1-2

XT SERIES VALVE ACTUATOR

Toggle the **MODE** button until the display reads **[PASS.]** (Fig 2.1-1), and then press the **ENTR** button to enter passcode mode. After the **ENTR** button is toggled, the display reads **[PASS]** for one second and then shows four zeros; the first one is blinking. Use the knob to scroll the number up or down. When the desired number is displayed, press the **ENTR** button. The next number will now blink. Continue this process until all the numbers are entered (Fig 2.1-2). When a valid passcode is entered the display will read unlock **[ULoC]** (Fig 2.1-3) or error lock **[ELoC]**. **[ULoC]** indicates that all other normal modes are now available for selection. **[ELoC]** indicates that additional modes are not available due to error conditions. This typically happens when both the primary and secondary (backup) valve position sensors have failed.

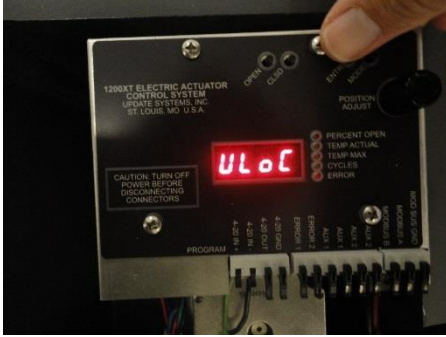

Fig 2.1-3



Fig 2.1-4

In order to relock the unit, enter **[PASS]** mode as previously described and then press the **ENTR** button four times. **[LoC]** is displayed to indicate the additional normal modes are locked out (Fig 2.1-4). Any incorrect passcode will lock the unit.

2.2 MANUAL [USER] MODE

As shown Fig 2.2-1, toggle the **MODE** button until the display reads **[USEr.]**, and then press the **ENTR** button to enter manual mode. After the **ENTR** button is toggled, the display will read **[USEr]** for one second and then show a number as in Fig 2.2-2. The number is the raw degrees as seen by the shaft position sensor.

The raw shaft position number can be used to verify the delta between two position points. Please note that



Figure 2.2-1



Figure 2.2-2

manual mode allows 360 degree turning of the shaft. Once the unit is calibrated, the user cannot move the valve beyond its calibrated limits. To move the shaft in **[USEr]** mode, simply turn the **POSITION ADJUST** knob. As the motor runs, the right most decimal indicator blinks. The rate of the blink corresponds to the relative speed of the motor (i.e. faster rate of blinking during acceleration).

For quick manual control over a calibrated actuator, see [Manual Override Mode](#).

XT SERIES VALVE ACTUATOR

2.3 4-20 [AUTO] MODE

During normal operation, the actuator will be in the 4-20 (current) mode, Open/Close, On/Off or one of the MODBUS modes. The AUTO mode requires an input in the 4-20 IN/OUT port (Pins 1 and 2) as

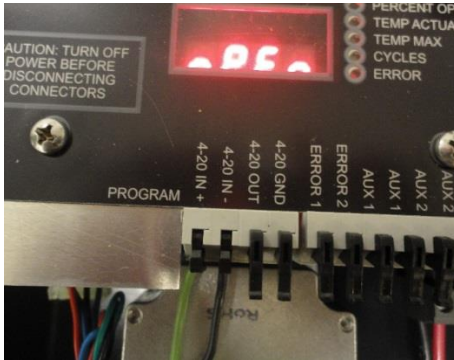

Fig 2.3-1

shown in **Fig 2.3-1**. The input is a non-polarized differential input, but the standard connection is shown on the unit. The output pins 3 and 4 of the 4-20 port provide a current signal that is proportional to the percentage that the valve is open. For example, the output will drive 20mA for a fully open valve (100% open), 12mA for a half open valve (50% open), and 4mA for a fully closed valve (0% open). The 4-20 input should be calibrated to the actual input for maximum accuracy. The calibration procedure is described in detail in the next section.

To enter 4-20 mode press the **MODE** button until the display reads **[AUto.]** (**Fig 2.3-2**), and then press the **ENTR** button (**Fig 2.3-3**). In this mode, the valve will respond to the input 4-20 current source. The **[AUto]** mode can display the status of four items: *Percent Open*, *Temp Actual*, *Temp Max*, and *Cycles* (see **Table 2.3-1**). Press the **ENTR** button to cycle through the status options. The Temp Actual and Temp Max options may be viewed in Fahrenheit or Celsius by turning the **POSITION ADJUST** knob.



Figure 2.3-1

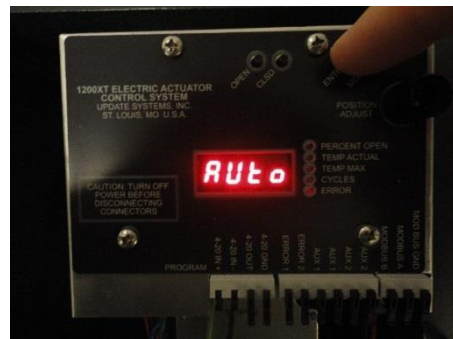

Figure 2.3-3

XT SERIES VALVE ACTUATOR



 <p>The image shows the front panel of a 1200XT Electric Actuator Control System. The red LED display shows the number '92.2'. To the right of the display are four indicator lights labeled 'PERCENT OPEN', 'TEMP ACTUAL', 'TEMP MAX', and 'CYCLES'. Below these are three more indicator lights labeled 'ERROR', 'MODE', and 'ENTR'. A 'POSITION ADJUST' knob is visible on the right side of the panel.</p>	<p>Percent Open</p>	<p>Indicates percentage that valve is open. It directly reflects the current state of the valve base on the main shaft sensor. The 4-20 output is related to this value with 4mA meaning 0% open and 20mA meaning 100% open.</p>
 <p>The image shows the front panel of a 1200XT Electric Actuator Control System. The red LED display shows the number '31.0'. To the right of the display are four indicator lights labeled 'PERCENT OPEN', 'TEMP ACTUAL', 'TEMP MAX', and 'CYCLES'. Below these are three more indicator lights labeled 'ERROR', 'MODE', and 'ENTR'. A 'POSITION ADJUST' knob is visible on the right side of the panel.</p>	<p>Temp Actual</p>	<p>Indicates the current internal temperature of the actuator. This reading is updated every second. The default format is Celsius. The temperature may be viewed in Fahrenheit by turning the POSITION ADJUST knob.</p>
 <p>The image shows the front panel of a 1200XT Electric Actuator Control System. The red LED display shows the number '56.0'. To the right of the display are four indicator lights labeled 'PERCENT OPEN', 'TEMP ACTUAL', 'TEMP MAX', and 'CYCLES'. Below these are three more indicator lights labeled 'ERROR', 'MODE', and 'ENTR'. A 'POSITION ADJUST' knob is visible on the right side of the panel.</p>	<p>Temp Max</p>	<p>Indicates the maximum internal temperature that the actuator has ever reached. The default format is Celsius. The temperature may be viewed in Fahrenheit by turning the POSITION ADJUST knob.</p>
 <p>The image shows the front panel of a 1200XT Electric Actuator Control System. The red LED display shows the number '2.8E5'. To the right of the display are four indicator lights labeled 'PERCENT OPEN', 'TEMP ACTUAL', 'TEMP MAX', and 'CYCLES'. Below these are three more indicator lights labeled 'ERROR', 'MODE', and 'ENTR'. A 'POSITION ADJUST' knob is visible on the right side of the panel.</p>	<p>Cycles</p>	<p>Indicates the total number of actuator start cycles. The number is displayed in scientific notation, where E_n represents 10^n. For example, the number displayed in the adjoining figure (2.8E5) is equal to 280,000 cycles.</p>

Table 2.3-1
Description of Status Indicators

XT SERIES VALVE ACTUATOR

2.4 MODBUS [dbUS] MODE

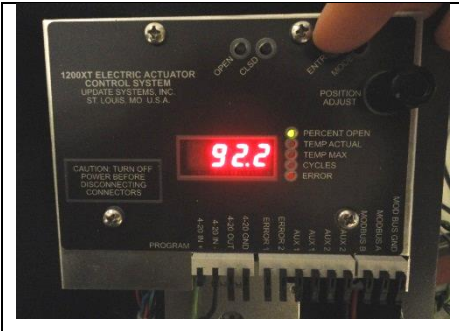
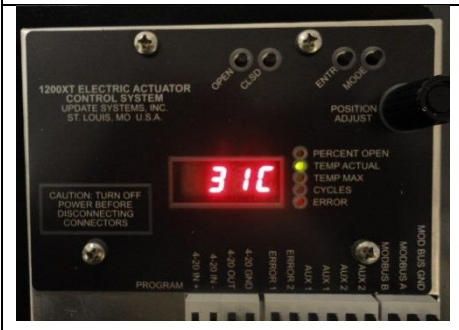
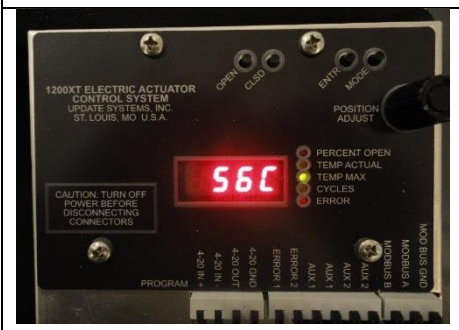
Actuator control in normal operation can be set to MODBUS [DBUS] mode. This mode requires an input in the MODBUS A(-) and MODBUS B(+) ports as shown in **Fig 2.4-1**. MOD BUS GND terminal is a



Fig 2.4-1

fully isolated ground connection (i.e. isolated from the actuator signal ground). This can be used to reference a single-ended master ground if desired. A full description of the MODBUS control set is given in **Table 2.4-1**. DBUS mode only requires positional calibration as described in the Calibration section. MODBUS registers may be queried in AUTO and OPEN/CLOSE modes to get status information.

To enter standard MODBUS control mode press the **MODE** button until the display reads [dbUS.] (**Fig 2.4-2**), and then press the **ENTR** button (**Fig 2.4-3**). In this mode, the valve will respond to the read and write messages as described in **Table 2.4-1**. The [dbUS] mode can display the status of four items: *Percent Open*, *Temp Actual*, *Temp Max*, and *Cycles* (see **Table 2.3-1**). Press the **ENTR** button to cycle through the status options. The Temp Actual and Temp Max options may be viewed in Fahrenheit or Celsius by turning the **POSITION ADJUST** knob.

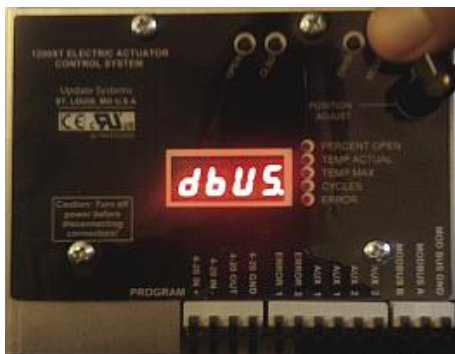

Fig 2.4-2



Fig 2.4-3

See **Table 2.4-2** for a sample list of example messages.

XT SERIES VALVE ACTUATOR

Coil/ Register ^[1]	Address	Size	Mode (R/W)	Data Type	Description
1	0	1	R/W	bool	OPEN/CLOSE Forced Coil Output (1 = "OPEN", 0 = "CLOSE")
10001	0	1	R	bool	[Valve Fully Open] AUX1 Output Status (1 = "on", 0 = "off")
10002	1	1	R	bool	[Valve Fully Closed] AUX2 Output Status (1 = "on", 0 = "off")
10003	2	1	R	bool	ERROR Output Status (1 = "on", 0 = "off")
10004	3	1	R	bool	ERROR: Motor Voltage Too Low (CODE 1) (1 = "on", 0 = "off")
10005	4	1	R	bool	ERROR: Input 4-20mA Invalid (CODE 2) (1 = "on", 0 = "off")
10006	5	1	R	bool	ERROR: Main Encoder Not Working (CODE 3) (1 = "on", 0 = "off")
10007	6	1	R	bool	ERROR: Motor Voltage Too High (CODE 4) (1 = "on", 0 = "off")
10008	7	1	R	bool	ERROR: Open/Close Inputs Invalid (CODE 5) (1 = "on", 0 = "off")
10009	8	1	R	bool	ERROR: Open/Close Interface Disconnected (CODE 6) (1 = "on", 0 = "off")
10010	9	1	R	bool	ERROR: Motor Is Stalled (CODE 0) (1 = "on", 0 = "off")
30001	0	1	R	ushort	Current Valve Percent Open (least significant digit is tenth's place. (i.e. 237 = 23.7° open)
30002	1	1	R	ushort	Current Temperature (°C) (56 = 56 °C)
30003	2	1	R	ushort	Maximum Temperature (°C) (75 = 75 °C)
30004 - 005	3 - 4	2	R	ulong	Number of Cycles (30004 == BITS[31...16], 30005 == BITS[15...0])
40001	0	1	R/W	ushort	Desired Open Position (Deg) (i.e. 496 = 49.6° open)
40002	1	1	R/W	ushort	Shaft Speed (%/10) ^[2] (0 - 10) (Default: 10)

[2] see Table 2.10-2

Coil/Register Numbers	Data Addresses	Type	Table Name
1-9999	0000 to 270E	Read-Write	Discrete Output Coils
10001-19999	0000 to 270E	Read-Only	Discrete Input Contacts
30001-39999	0000 to 270E	Read-Only	Analog Input Registers
40001-49999	0000 to 270E	Read-Write	Analog Output Holding Registers

Table 2.4-1
XT Series Electric Actuator MODBUS Register Map

XT SERIES VALVE ACTUATOR

	XT Mode	Master Request	HEX based RTU Message				
		Slave Response	Device ID	Function	Address/ # of bytes	Value	CRC
Master	oBUS only	Open valve 100% (coil write)	01	05	00 00	FF 00	8C 3A
Slave			01	05	00 00	FF 00	8C 3A
Master	oBUS only	Open valve 0% (Fully close)	01	05	00 00	00 00	8C 3A
Slave			01	05	00 00	00 00	8C 3A
Master	dBUS/ oBUS	Open valve 50.0% (single reg)	01	06	00 00	01 F4	89 DD
Slave	dBUS/ oBUS		01	06	00 00	01 F4	89 DD
Master	Any	Read input regs 0-5	01	04	00 00	00 05	30 09
Slave	Any		01	04	0A	01 F4 00 1F 00 38 00 2B 87 23	7D 69
01 F4 = 50% open, 00 1F = 31°C, 00 38 = 56°C, 002B 8723 = 2,852,643 cycles							
Master	Any	Read discrete inputs 0-9	01	02	00 00	00 0A	F8 0D
Slave	Any		01	02	02	16 00	B7 D8
16 00 = 0001 0110 0000 0000 = Valve fully closed AUX2 ON, ERROR Output Status RelayON, ERROR: Input 4-20mA invalid							

Table 2.4-2

Example MODBUS commands and responses

XT SERIES VALVE ACTUATOR

2.5 MODBUS OPEN/CLOSE [obUS] MODE

Actuator control in normal operation can be set to MODBUS [OBUS] mode. This mode is a variation of the DBUS mode in section 2.4 in which the control is limited by a single forced coil write command that completely opens the valve when “ON” or 1, and completely closes the valve when “OFF” or 0. See the first example in **Table 2.4-2**.



Fig 2.5-1

To enter OPEN/CLOSE MODBUS control mode press the **MODE** button until the display reads [obUS.] (Fig 2.5-1), and then press the **ENTR** button. In this mode, the valve will respond to the read and write messages as described in **Table 2.4-1**, except that it uses the **Forced Coil #1 write at address 0 instead of the Desired Open Position register at 40001, address 0**. The [obUS] mode can display the status of four items: *Percent Open*, *Temp Actual*, *Temp Max*, and *Cycles* (see **Table 2.3-1**). Press the **ENTR** button to cycle through the status options. The *Temp Actual* and *Temp Max* options may be viewed in Fahrenheit or Celsius by turning the **POSITION ADJUST** knob.

2.6 OPEN/CLOSE [OPCL] MODE

Actuator control in normal operation can be set to OPEN/CLOSE [OPCL] mode. This is an optional mode that requires an interface board and terminal block assembly, and will respond to ON/OFF inputs at the OPEN and CLOSE terminals. The interface can be factory configured to accommodate 24 to 48VDC or 100 to 240VAC control input. Referring to **Fig 2.6-1**, the OPEN signal is attached to terminal 1, neutral or DC COM is attached to 2 or 3, and the CLOSE signal is attached to terminal 4.

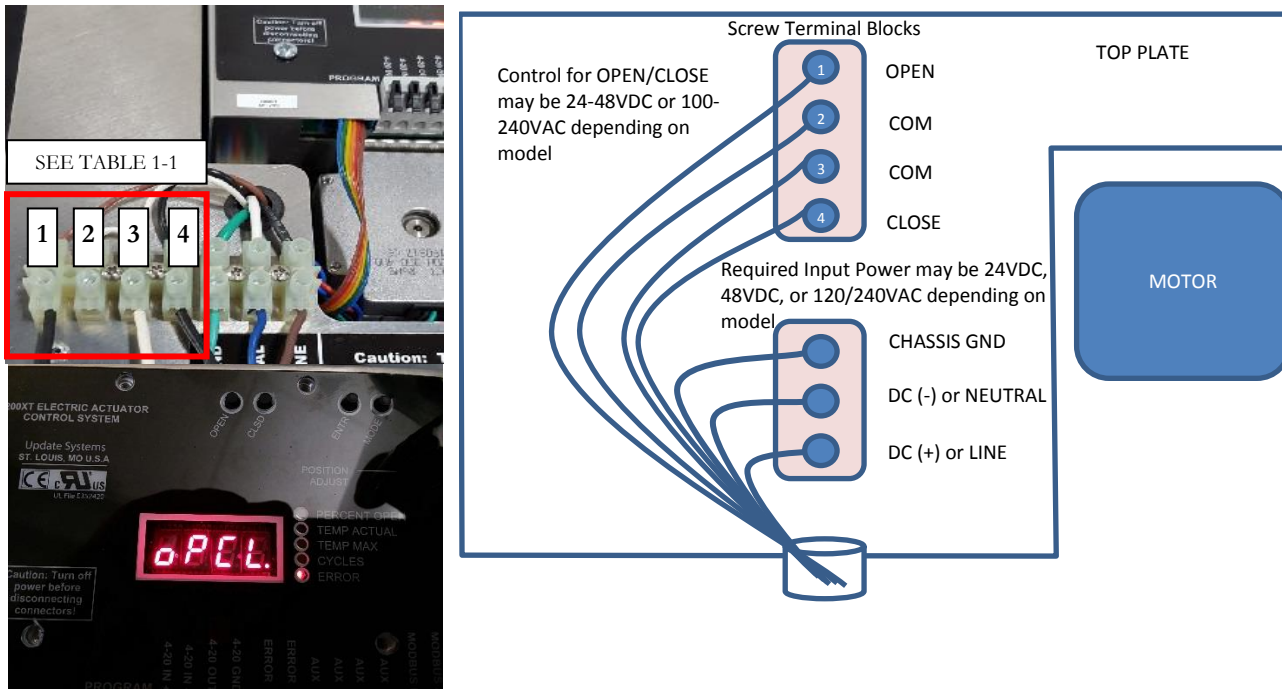

Fig 2.6-1: Wiring for Open/Close Mode

To enter OPEN/CLOSE control mode press the **MODE** button until the display reads [oPCL.], and then press the **ENTR** button. In this mode, the valve will respond to the ON/OFF inputs as described in **Table 2.6-1**. The [oPCL] mode can display the status of four items: *Percent Open*, *Temp Actual*, *Temp Max*, and *Cycles* (see **Table 2.3-1**). Press the **ENTR** button to cycle through the status options. The Temp Actual and Temp Max options may be viewed in Fahrenheit or Celsius by turning the **POSITION ADJUST** knob.

1 (OPEN)	4 (CLOSE)	
ON (HIGH)	OFF (LOW)	Actuator will move to the calibrated OPEN position.
OFF (LOW)	ON (HIGH)	Actuator will move to the calibrated CLOSED position.
OFF (LOW)	OFF (LOW)	E-05 error, actuator moves to calibrated DEFAULT position.
ON (HIGH)	ON (HIGH)	E-06 error, actuator moves to calibrated DEFAULT position.

Table 2.6-1: OPEN/CLOSE Functional Logic

This mode of operation requires positional calibration only. See section 2.8.3.

2.7 ON/OFF [onOF] MODE

Actuator control in normal operation can be set to ON/OFF [ONOF] mode. This is variation of the OPEN/CLOSE Mode that applies VAC supply power to either OPEN or CLOSE input control. When the unit is powered, the control is also powered and travels to the respective position after 5 seconds. When power is cut from the actuator, the super cap backup supply will allow the actuator to travel to the DEFAULT calibrated position. The Motor Voltage Is Too Low Error [E-01] and the Open/Close Inputs Invalid Error [E-05] are suppressed in this mode. NOTE: This mode REQUIRES actuator VAC power supply and super cap backup options. **Fig 2.7-1** shows wiring for OPEN when power is applied (ON) and CLOSE when power is cut (OFF). The OPEN signal is attached to terminal 1, neutral is attached to 2 or 3, and terminal 4 is left unconnected. The DEFAULT position in this case would be set to CLOSED during position calibration.

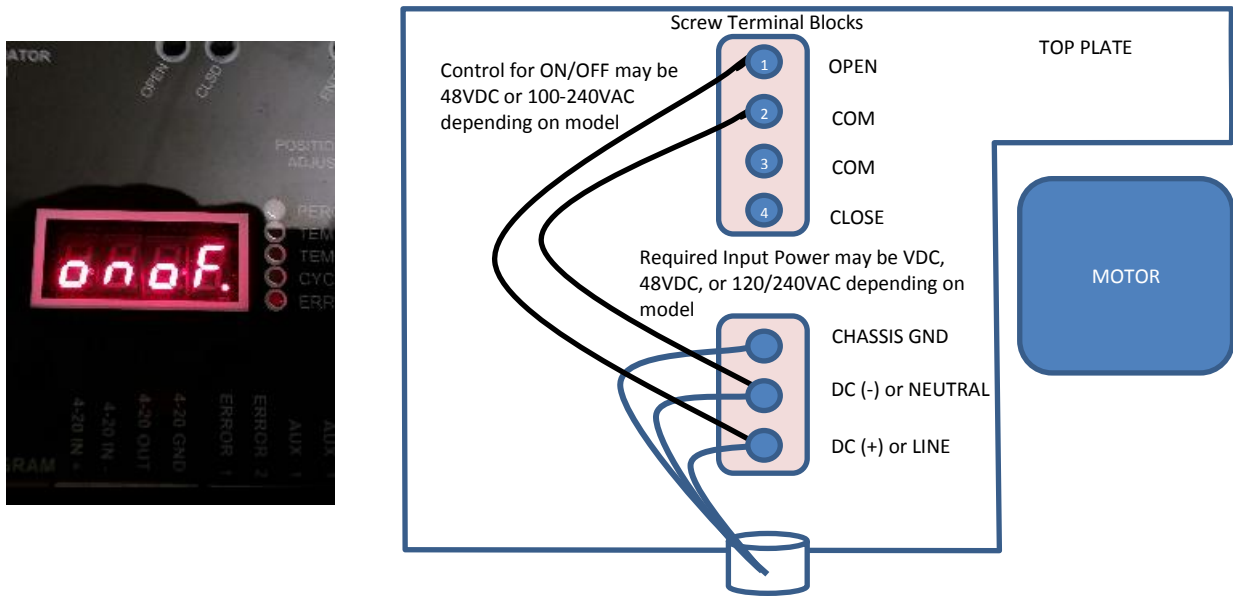

Figure 2.7-1: ON/OFF wiring for Open ON/Close OFF

This mode of operation requires positional calibration only. See section 2.8.3 for instructions.

XT SERIES VALVE ACTUATOR

2.8 CALIBRATION [CAL] MODE

The XT Series is designed to easily calibrate valve range, valve direction, and 4-20 input. The unit requires BOTH 4-20 input and physical position calibration for loop current [AUto] mode. Position only calibration is required for MODBUS [dbUS]/[obUS] and OPEN/CLOSE [oPCL]/ [onoF] modes. Three calibration menu options are available, full calibration [FCAL], position only [pCAL], and 4-20mA input only [iCAL]. Once calibrated, the actuator simply returns the percentage open (0% - 100%) when placed in [AUto] mode. The current output will linearly supply a range starting at 4mA for valve zero percent open through 20mA for valve one hundred percent open. The step-by-step procedure to calibrate the unit is given below. The controller is designed to calibrate the 4-20 input and position with a single step. Remote calibration, covered in the next section, can be used to calibrate physical position only.

2.8.1 FULL CALIBRATION ONLY [FCAL] MODE



Fig 2.8.1-1

Step 1: To enter calibration [CAL] mode, toggle the **MODE** button until [CAL.] is displayed (Fig 2.8.1-1), then press the **ENTR** button.

Step 2: After entering [CAL] mode, the display will read [FCAL] as shown in Fig 2.8.1-2. Press the **ENTR** button to enter this cal mode. The display will read [oPEn]. If desired, turn the knob to select the position [pCAL] or 4-20 only calibration modes [iCAL] (see the corresponding next two sections). The unit may now be calibrated for the valve-open 4-20 input and the desired valve-open position. Apply the desired current input signal on the 4-20 IN/OUT port pins 1 and 2 to be associated with valve open (e.g. Fig 2.8.1-3). The main machine controller (e.g. a PLC) normally provides the reference input. The XT Series will calibrate to an input ranging from 3mA to 23mA.

***Step 3:** *If position is to be calibrated with the controller, follow this step; otherwise, skip to step 4.* Next, use the **POSITION ADJUST** knob to place the valve at the desired open position. As the knob is turned, the unit will display the raw feedback from the shaft sensor in degrees (Fig 2.8.1-4).



Fig 2.8.1-2



Fig 2.8.1-3

XT SERIES VALVE ACTUATOR

PLEASE NOTE: Turning the knob will move the valve one degree for each detent (**course adjust**). If the **OPEN** button is held down while the knob is turned, the valve position will attempt to adjust by a tenth of a degree for each detent (**fine adjust**). The actual resolution taking into account hysteresis for manual adjustment is two-tenths of a degree. Once the **OPEN** button is released, the current 4-20 input and position will be stored.



Fig 2.8.1-4

Step 4: To preserve a previous Open calibration, press **ENTR** to skip (the current raw position will flash on display); otherwise, press and release the **OPEN** button to store the input reference [and position]. If fine adjust was used as described in Step 3, then simply release the **OPEN** button. If Step 3 was skipped, Remote calibration may be used to set the position. The unit will display **[SEt]** to indicate that the calibration parameters have been saved for open position as shown in Fig 2.8.1-5.

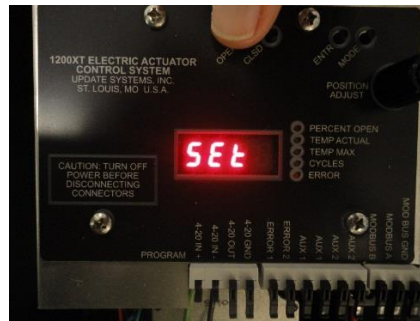

Fig 2.8.1-5

Step 5: When the display reads **[CLoS]**, the unit is ready to calibrate valve closed. Apply the desired 4-20 input as described in Step 2.

***Step 6:** If position is to be calibrated with the controller, follow this step; otherwise, skip to step 7. Next, use the **POSITION ADJUST** knob to place the valve at the desired closed position (Fig 2.8.1-6 and Fig 2.8.1-7), as described in Step 3.



Fig 2.8.1-6



Fig. 2.8.1-7

XT SERIES VALVE ACTUATOR

Step 7: To preserve a previous Closed calibration, press **ENTR** to skip (the current raw position will flash on display); otherwise, press and release the **CLSD** button to store the input reference [and position]. If fine adjust was used as described in Step 6, then simply release the **CLSD** button. The unit will display **[SEt]** to indicate that the calibration parameters have been saved for closed position as shown in **Fig 2.8.1-8**.



Fig 2.8.1-8

Step 8: When the display reads **[dFLt]** (**Fig 2.8.1-9**), the unit is ready to calibrate valve default safe position in the event of an error event (e.g. undervoltage, or power failure). Press and release the **OPEN** button to set the default safe position to valve fully open. Press and release the **CLSD** button to set the default safe position to fully closed. Alternatively, turn the **POSITION ADJUST** knob to a desired position and press **ENTR**. **For applications needing valve to “stop in place” and not move as default error position, press and hold ENTR for more than two (2) seconds. The display will show [SiP] and then can be released.** Once the **OPEN**, **CLSD**, or **ENTR** button is toggled, the unit will automatically calibrate the backup sensor. See *Backup Calibration Mode for more detail*. Once calibration is complete, and the display will show **[donE]** (**Fig 2.8.1-10**) and then revert back to **[FCAL]** after two seconds. The unit may be recalibrated at any time. See next page for FULL CALIBRATION Flowchart.



Fig 2.8.1-9

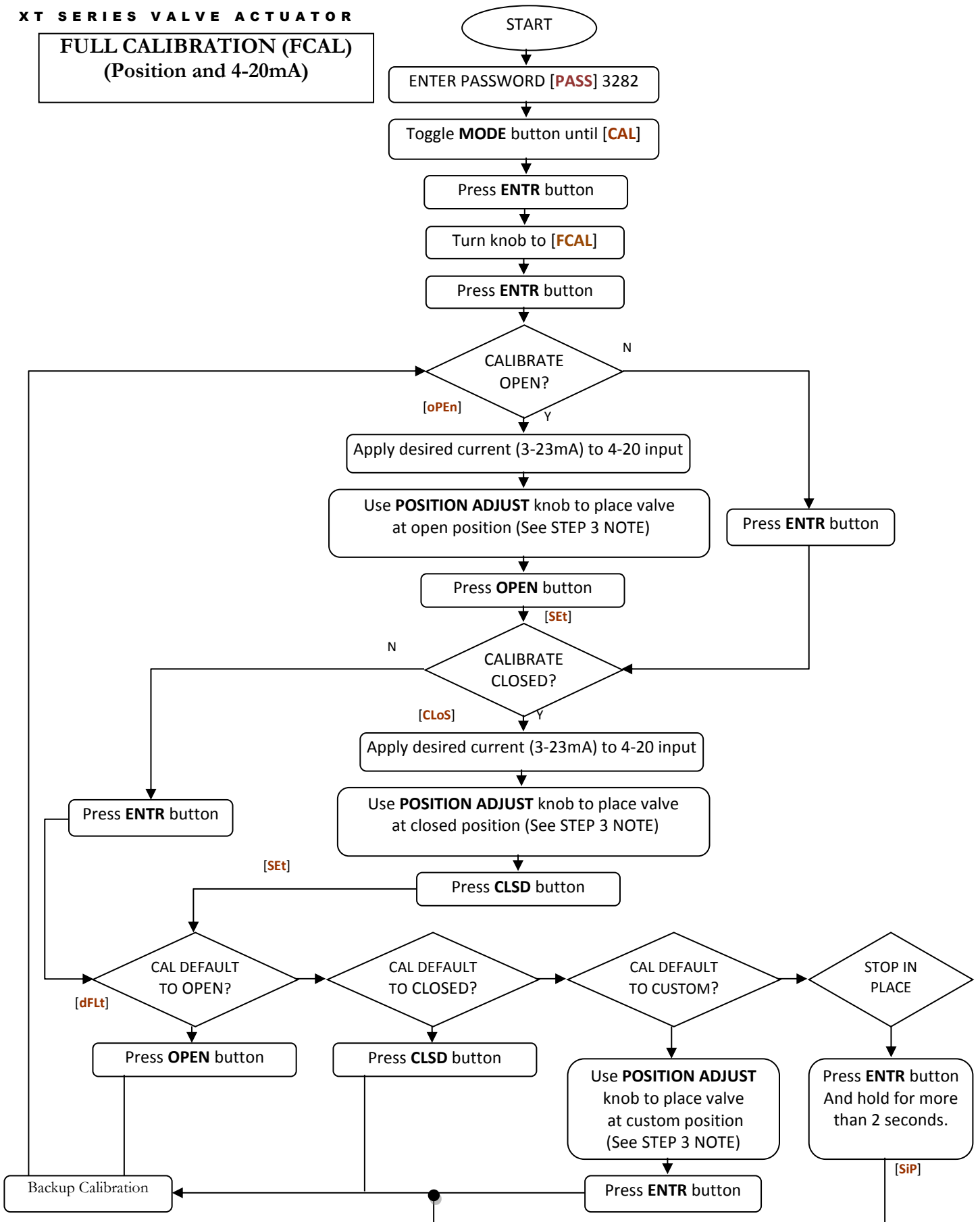

Fig. 2.8.1-10

***Note:** If the full open and full closed positions are equivalent, the valve will not move as the 4-20 input signal is swept across its range.

XT SERIES VALVE ACTUATOR

**FULL CALIBRATION (FCAL)
(Position and 4-20mA)**



XT SERIES VALVE ACTUATOR

2.8.2 4-20mA CALIBRATION ONLY [iCAL] MODE

This mode of calibration is identical to the previous method EXCEPT that the valve POSITION calibration is NOT affected. [iCAL] mode is useful if the 4-20mA signal needs to be calibrated (or recalibrated), but the user does not want to affect the physical position calibration. No backup sensor calibration is necessary. See Flow Chart below.

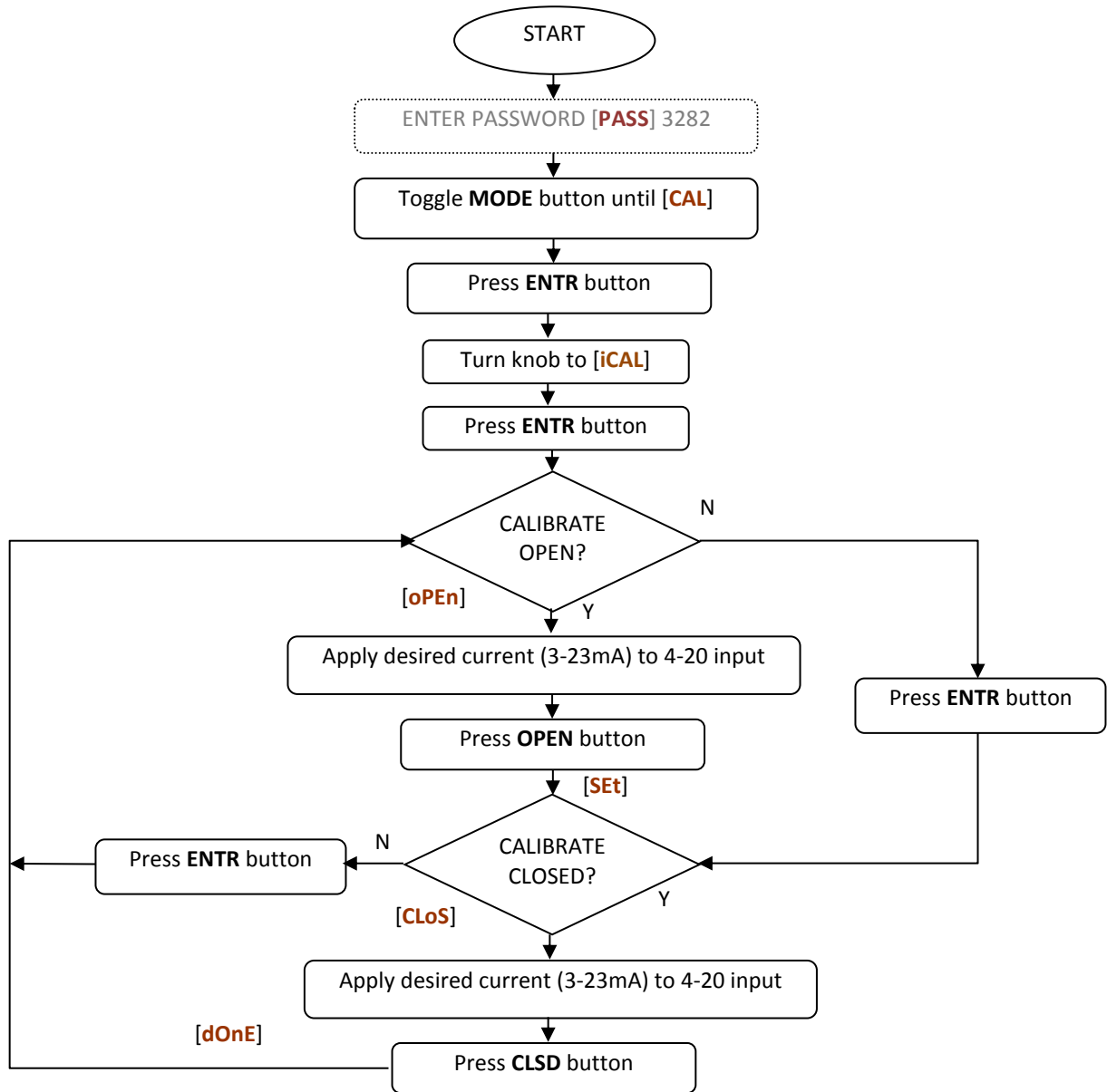

XT SERIES VALVE ACTUATOR

2.8.3 POSITION CALIBRATION ONLY [PCAL] MODE

This mode of calibration is identical to the FCAL method EXCEPT that only the valve POSITION calibration is affected. [PCAL] mode is useful if only the position needs to be calibrated (or recalibrated), but the user does not want to affect the 4-20 mA calibration, or if using MODBUS [dbUS] or OPEN/CLOSE [oPCL] control mode. Backup sensor will automatically recalibrate. See Flow Chart below.

XT SERIES VALVE ACTUATOR

POSITION ONLY CALIBRATION (PCAL)

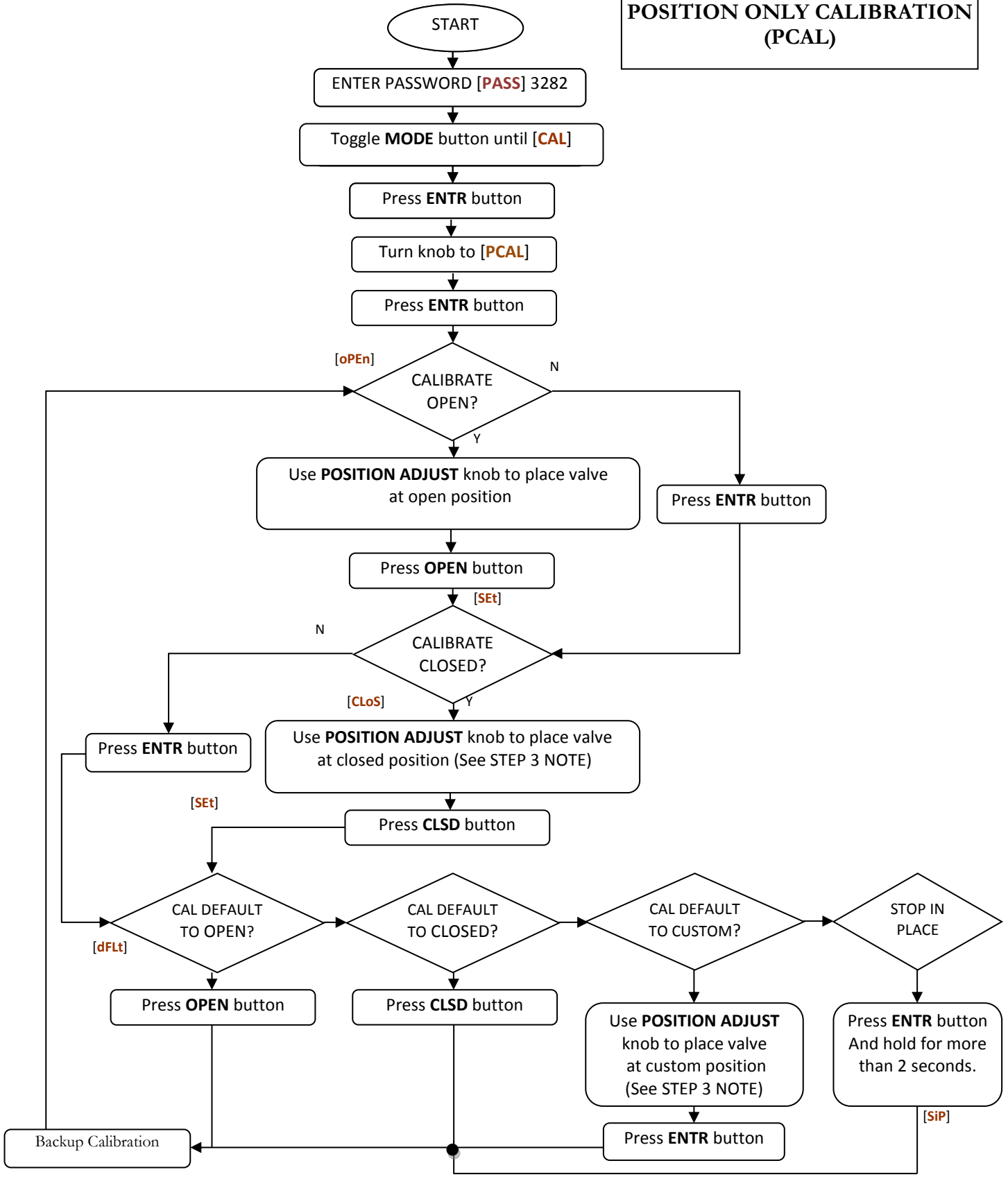

2.9 BACKUP CALIBRATION [bCAL] MODE

The backup shaft position sensor maintains valve operation in the event of main sensor failure. This allows machine operation to continue until the unit is repaired. The backup sensor is specifically designed for ninety-degree valve. If backup calibration fails, unit will still operate with main encoder and no error will display. **In the event of a main position encoder failure, the unit will attempt to run in backup mode. The PERCENT OPEN lamp will blink steadily indicating that the unit is in backup mode. The PERCENT OPEN lamp will double blink if the main and backup encoder have both failed, indicating the unit is operating using saved step counts with no feedback. In either case, the unit will continue to run but should receive maintenance as soon as possible.**

Backup calibration is automatically engaged after a successful position calibration through a full calibration [FCAL], or position only calibration [pCAL]. The valve will first initialize to the closed position [brSt] (Fig 2.9-1). The valve will then turn back and forth through the whole previously calibrated range. During the calibration, the controller is searching for four magnetic transitions. The count is displayed as -b # and b- # (Fig 2.9-2). Once the backup sensor is successfully calibrated, the display will read [donE]. If the backup calibration is unsuccessful, the display will read [bErrr].

Backup calibration may be manually initiated by toggling the MODE button and entering [bCAL] (Fig 2.9-3). Once [bCAL] is selected, the display reads [Strt]. Press ENTR to begin calibration. As described previously, the display will read [donE] upon successful calibration; otherwise [bErrr].

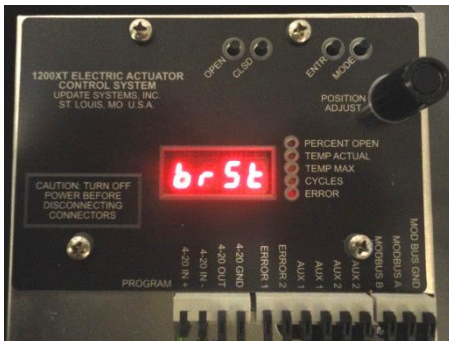

Fig 2.9-1

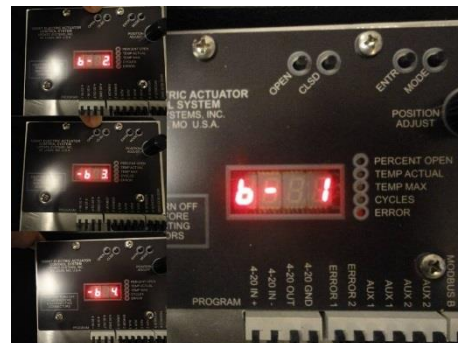

Fig 2.9-2

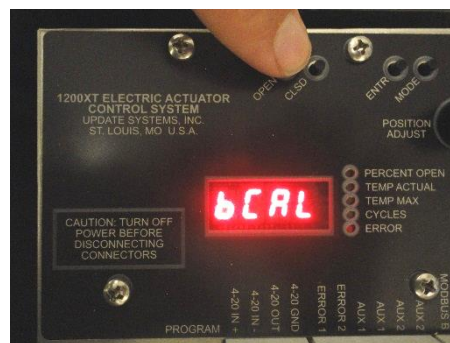

Fig 2.9-3

2.10 ERROR [Err] MODE

An Error mode is available for menu selection when a system error is present. Currently, the XT Series has eight standard error codes. A description of these codes is given in **Table 2.10-1**.

CODE	NAME	DESCRIPTION	RESPONSE
E-00	Motor Has Stalled.	Detected motor stall or slip due to over-torque. (e.g. blocked or worn valve). Fault can also occur due to faulty or no connection of the MOTOR port.	Actuator will restart at half speed to increase torque. If proper movement resumes, it will restart to the saved speed (step rate). If it continues to slip, motor is restarted to lowest speed setting (highest torque) and will continue this process until normal movement is achieved, at which it will resume to the saved speed setting.
E-01	Motor Voltage Is Too Low	The supply voltage has fallen below 40.0V DC. Usually indicates power failure.	If super cap option is installed, power backup will allow actuator to reach the DEFAULT position set during calibration. Suppressed in [onoF] mode.
E-02	Input 4-20 Is Invalid	The 4-20 current input is invalid. This fault can occur due to an open or shorted input.	If in AUTO mode, actuator will move to DEFAULT position set during calibration. This error is suppressed in modes of operation other than [AUto].
E-03	Main Encoder Is Not Working	No valid or stable feedback from main shaft encoder. Fault can occur due to main shaft encoder failure.	Actuator will revert to raw step count positioning and relies on backup magnet detection to correct accumulated position error. Actuator should be serviced or replaced when possible. This error will also inhibit the E-00 error detection.
E-04	Motor Voltage Is Too High	Nominal supply voltage is above 51.0V	Voltage supply to the actuator too far above the 48VDC and may damage the motor driver. Check input power and correct.
E-05	Open/Close Inputs Invalid	Both OPEN and CLOSE inputs are OFF (LOW) when using [oPCL] mode.	If in [oPCL] mode, actuator will move to DEFAULT position set during calibration until only one input is ON. Suppressed in [onoF] Mode.
E-06	Open/Close Interface Disconnected	Both OPEN and CLOSE inputs are ON (HIGH) or interface is disconnected when using [oPCL] mode.	If in [oPCL] mode, actuator will move to DEFAULT position set during calibration until only one input is ON and/or interface board is connected.
E-07	MODBUS Comm Timeout	Communication from the Master has ceased for set amount of time.	Actuator will move to DEFAULT position set during calibration. This error is suppressed in modes of operation other than [dBUS] and [oBUS].

Table 2.10-1
Actuator Error Codes

XT SERIES VALVE ACTUATOR

Any of the listed errors will result in the, the ERROR indicator will light, the Error relay will open (RELAYS port, pins 1 and 2, see **Table 1-1**), and the display will flash between the errors and the current mode status at a one second interval. The Input 4-20 error and MODBUS Comm Timeout (when in obUS or dbUS mode) will cause the valve to move to default safe position if possible. All errors will automatically clear when the fault is corrected. In the case of complete actuator power failure, the ERROR relay will open.

To enter **[Err]** mode, toggle the **MODE** button until the display reads **[Err.]** and press **ENTR** (**Fig 2.10-1**). One or more error codes may be present (**Fig 2.10-2**). Use the **POSITION ADJUST** knob to scroll through

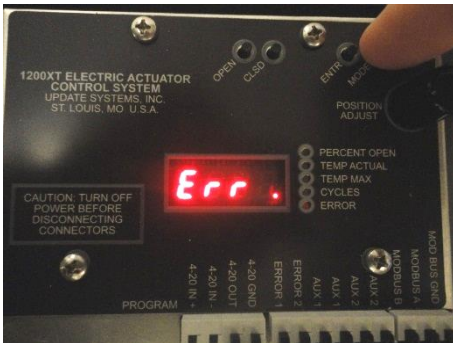

Fig 2.10-1

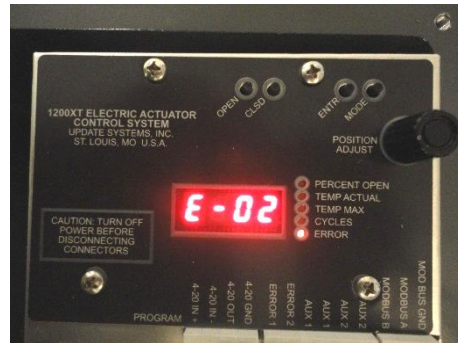

Fig 2.10-2

the current fault list. To manually clear all errors, toggle the **ENTR** button. The display will read **[ECLr]** (**Fig 2.10-3**). Press and release the **ENTR** button again within one second and the error will clear. The controller will then display error codes that still exist or revert back to the previous mode if no other errors are present. The actuator will attempt to move to the desired position and re-flag the error if there is still a problem.



Fig 2.10-3

XT SERIES VALVE ACTUATOR

2.11 MANUAL OVERRIDE [ovER] MODE

This is a special mode that can be used to quickly gain manual control over the actuator when in a signal-controlled mode (i.e. 4-20mA Auto, MODBUS, or Open/Close). Press and hold the **OPEN** button or **CLSD** button for five (5) seconds. After the first second, the display will show a count-down [or 3].. [or 2].. [or 1].. [or 0]. If the button is released during this count-down, override mode request is canceled and actuator will continue normally. At the end of the countdown, if the button press is maintained, the display will show [ovEr], the green status selection LEDs will flash on/off, and the actuator will immediately start moving toward the calibrated OPEN or CLOSED position based on which button is pressed. While in this mode, the actuator will only respond to the **OPEN** and **CLSD** button. The actuator will remain in this mode until another mode is selected, even through a power cycle.

2.12 CONFIGURATION [CnFg] MODE

This mode is used to configure the actuator motor speed, the default state of the relays (ERROR, AUX1, and AUX2), MODBUS device address, and MODBUS baud rate.

Step 1: To enter Configuration [CnFg] mode, toggle the **MODE** button until [CnFg.] is displayed (Fig 2.12-1), then press the **ENTR** button.



Fig 2.12-1

Step 2: Turn the knob to desired configuration setting to change and press the **ENTR** button. To exit current configuration setting, press **MODE** button and wait. Menu will take you back to the first selection. Refer to **Table 2.12-1** for configuration setting descriptions.

XT SERIES VALVE ACTUATOR

	<p>Step Rate</p>	 	<p>After entering [CnFg] mode, the display will read [rAtE] as shown. Press the ENTR button and display will read [Sr #]. Turn the knob to desired speed setting and press the ENTR button. Refer to Table 2.10-2 for the Step Rate vs. speed.</p>
	<p>Relay Output Default State</p>	 	<p>Press the OPEN or CLSD button to check current relay status (i.e. normally closed [nCLd], or normally open [noPn]). While the current switch status is displayed, the default may be changed by pressing the OPEN or CLSD button for normally open [noPn] or normally closed [nCLd], respectively</p>
	<p>MODBUS Device Address</p>		<p>The MODBUS Device address may be assigned by turning the POSITION ADJUST knob. Press the ENTR button to save new address.</p>
	<p>MODBUS Baudrate</p>		<p>The MODBUS Baudrate may be assigned by turning the POSITION ADJUST knob. Press the ENTR button to save new baudrate.</p> <p>[b384] = 38400 [b192] = 19200 [b 96] = 9600 [b 48] = 4800</p>

XT SERIES VALVE ACTUATOR

	<p>MODBUS Timeout</p>		<p>MODBUS communication timeout may be set from 0 to 9. 0 is infinite, or no timeout. 1 through 9 is times 10 seconds of timeout. e.g. setting 1 is 10 sec, 2 is 20 sec, ...9 is 90 sec. Assign setting by turning the POSITION ADJUST knob. Press the ENTR button to save new timeout. If timeout is not 0, the actuator will move to the DEFAULT calibrated position if comm is lost with the Master beyond this setting.</p>

Table 2.12-1
Actuator Configuration Options

XT Series Shaft speed config

StepRate (Sr)	sec/90°
10 (100%)	6.75
9	7.30
8	8.00
7	9.00
6	10.00
5	11.15
4	12.60
3	14.60
2	17.80
1	22.00
0 (0%)	30.50

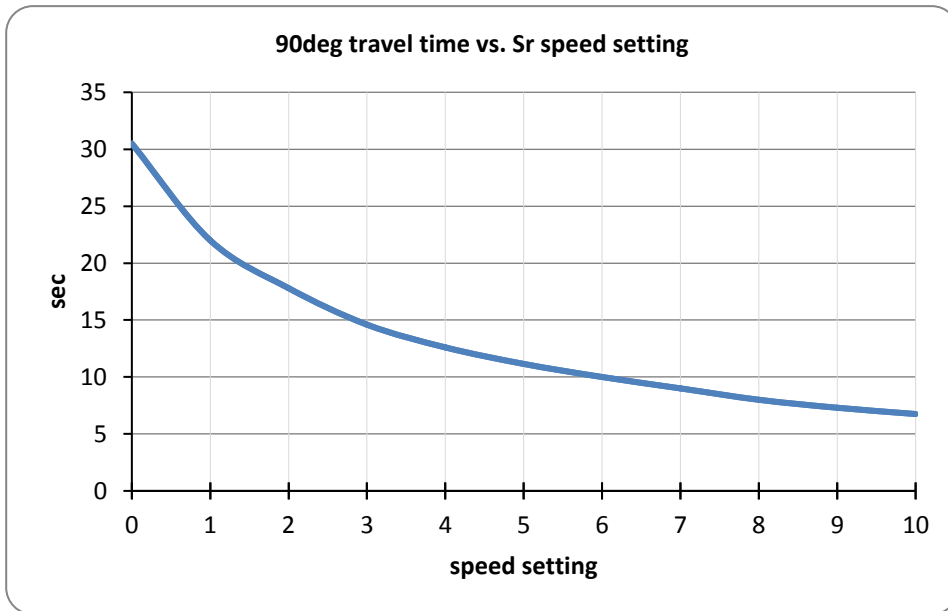
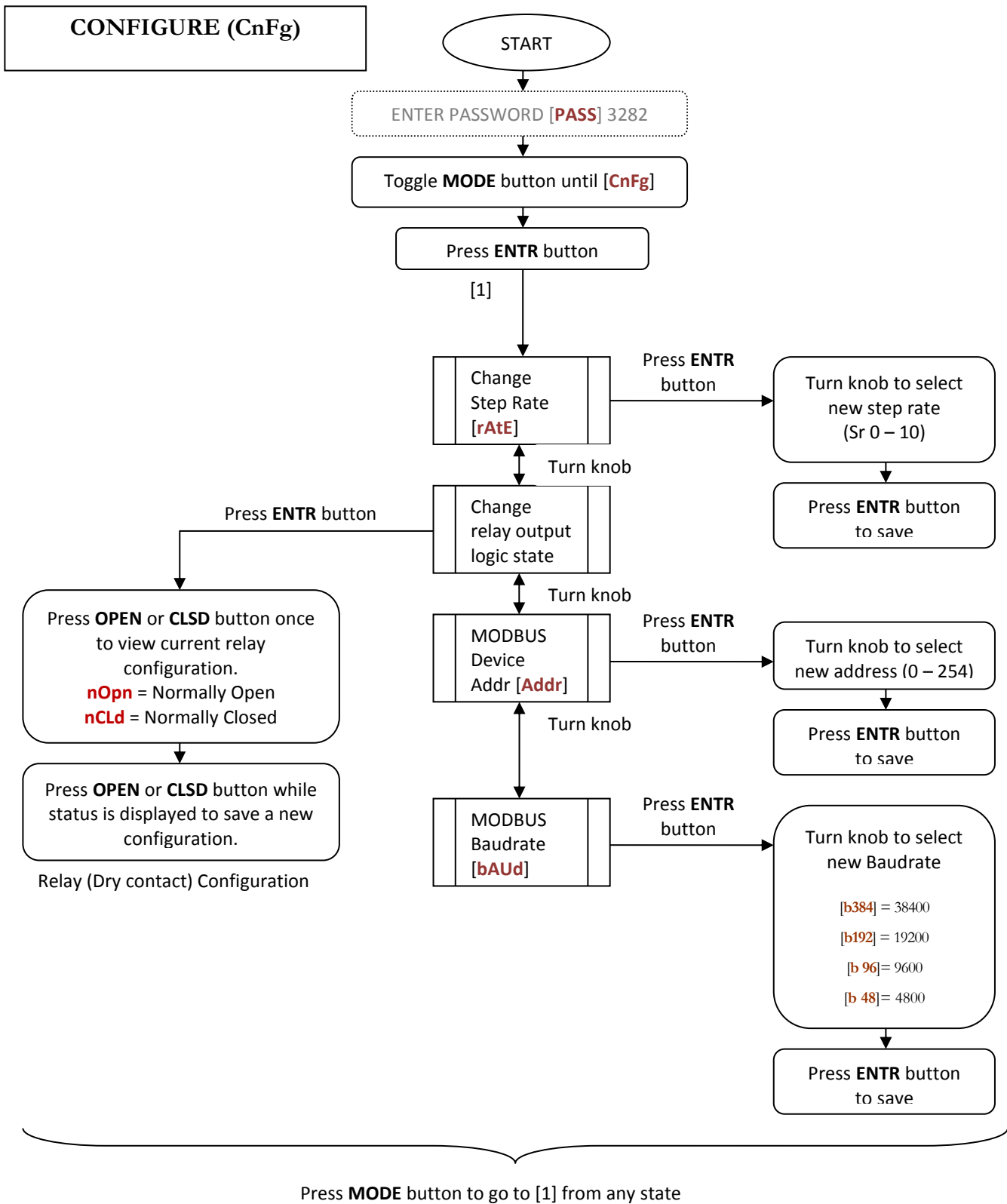

Table 2.10-2
Step Rate (SR) setting vs. Time

XT SERIES VALVE ACTUATOR



Overview

The XT Series features an external programming port (PROG) to easily upgrade the firmware. Attaching the USB-driven XT Series Programmer to the controller and running the Flash Magic boot-loader software included with this document package accomplish reprogramming the unit.

Boot-loader installation

Flash Magic boot-loader software must be installed on a PC with one available USB port. The installer program is provided in the document .zip package. It can also be downloaded from [2](#). Double-click on the FlashMagic.exe file and follow the installation instructions.

Programming Procedure

Step1: Attach the XT Series Programmer to the controller (**Fig 3.1**). The controller should be powered for reprogramming.

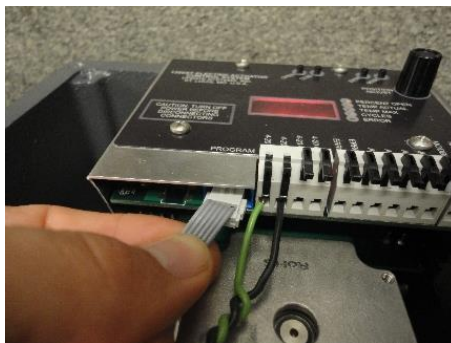

Fig 3.1

XT SERIES VALVE ACTUATOR

Step 2: Using a standard USB cable, connect the XT Series Programmer to a PC with Flash Magic installed.

Step 3: Open Flash Magic and configure as shown in **Fig 3.2**. Use Browse to select the .hex file (Version 0.01 is provided in the .zip document package). The XT Series Programmer will create a COM port when the USB is attached to the PC. Be sure the correct COM port is selected in Flash Magic. The available COM ports may be viewed through the Control Panel -> System Devices or by typing the command MODE in a DOS prompt.

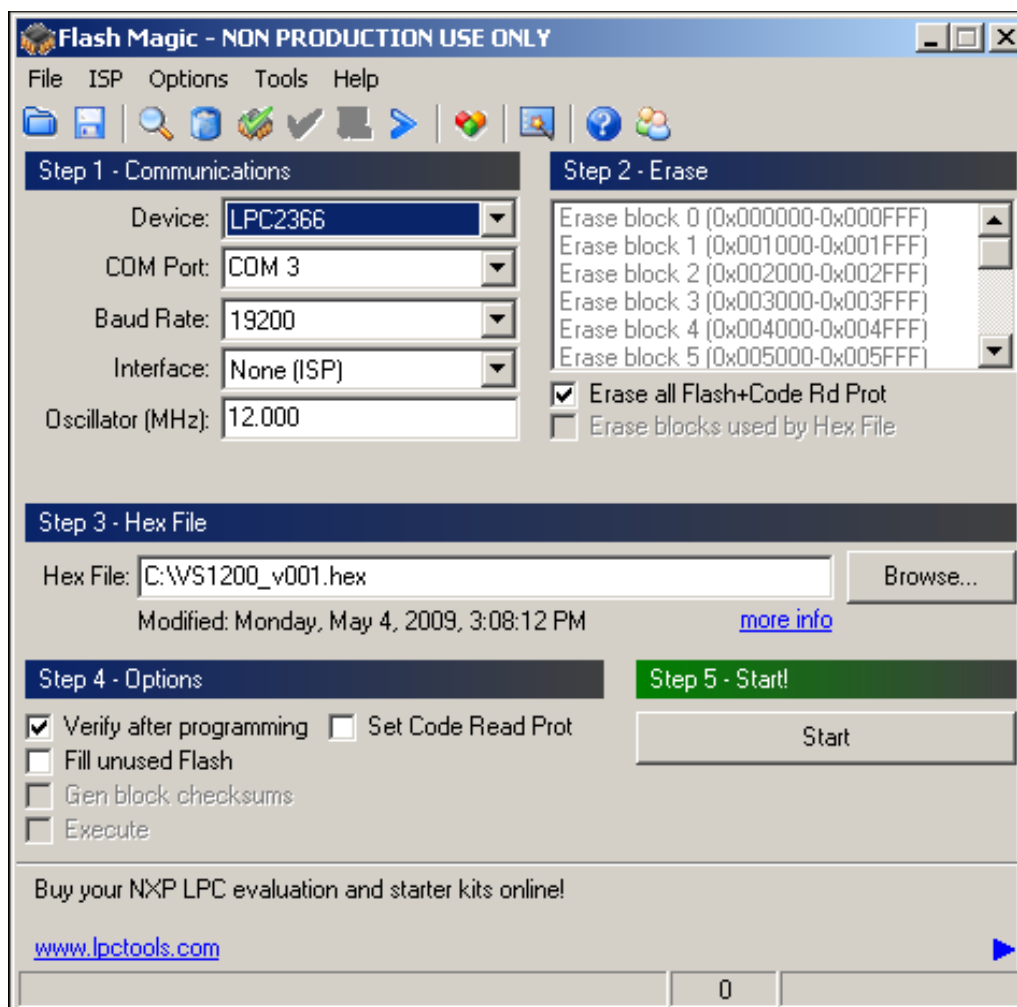

Fig 3.2

Step 4: Click Start and wait for programming and verification to complete.

Step 5: Unplug the XT Series Programmer and cycle power to the controller. The firmware update is now complete.